

Star coloring of sparse graphs

Yuehua Bu* Daniel W. Cranston† Mickaël Montassier‡
André Raspaud§ Weifan Wang¶

Abstract

A proper coloring of the vertices of a graph is called a *star coloring* if the union of every two color classes induce a star forest. The star chromatic number $\chi_s(G)$ is the smallest number of colors required to obtain a star coloring of G . In this paper, we study the relationship between the star chromatic number $\chi_s(G)$ and the maximum average degree $\text{Mad}(G)$ of a graph G . We prove that:

1. If G is a graph with $\text{Mad}(G) < \frac{26}{11}$, then $\chi_s(G) \leq 4$.
2. If G is a graph with $\text{Mad}(G) < \frac{18}{7}$ and girth at least 6, then $\chi_s(G) \leq 5$.
3. If G is a graph with $\text{Mad}(G) < \frac{8}{3}$ and girth at least 6, then $\chi_s(G) \leq 6$.

These results are obtained by proving that such graphs admit a particular decomposition into a forest and some independent sets.

1 Introduction

Let G be a graph. A *proper vertex coloring* of G is an assignment c of integers (or labels) to the vertices of G such that $c(u) \neq c(v)$ if the vertices u and v are adjacent in G . A k -*coloring* is a proper vertex coloring using k colors. The minimum k such that G has a k -coloring is called the *chromatic number* of G , denoted by $\chi(G)$.

A proper vertex coloring of a graph is *acyclic* if there is no bicolored cycle in G . In other words, the graph induced by the union of every every two color classes is a forest. The *acyclic chromatic number*, denoted by $\chi_a(G)$, of a graph G is the smallest integer k such that G has an acyclic k -coloring. The acyclic coloring of graphs was introduced by Grünbaum in [3].

Finally, a proper vertex coloring of a graph is called a *star coloring* if the union of every two color classes induces a star forest. The *star chromatic number*, denoted by $\chi_s(G)$, is the smallest integer k such that G has a star k -coloring.

**Departement of Mathematics, Zhejiang Normal University, Jinhua 321004, P. R. China, yhbu@zjnu.cn*

†*DIMACS, Rutgers University, Piscataway, New Jersey 08854, dcransto@dimacs.rutgers.edu*

‡*LaBRI UMR CNRS 5800, Université Bordeaux I, 33405 Talence Cedex, France, montassi@labri.fr*

§*LaBRI UMR CNRS 5800, Université Bordeaux I, 33405 Talence Cedex, France, raspaud@labri.fr*

¶*Departement of Mathematics, Zhejiang Normal University, Jinhua 321004, P. R. China, wwf@zjnu.cn*

Star colorings have recently been investigated by Fertin, Raspaud, and Reed [2], Nešetřil and Ossana de Mendez [4], and Albertson *et al.* [1].

Albertson *et al.* proved an interesting relationship between χ_s , χ , and χ_a of G and some structures of G (called *F-reductions*), which gives the following corollary.

Corollary 1 [1] *Let G be a planar graph.*

1. *If $g(G) \geq 3$, then $\chi_s(G) \leq 20$.*
2. *If $g(G) \geq 5$, then $\chi_s(G) \leq 16$.*
3. *If $g(G) \geq 7$, then $\chi_s(G) \leq 9$.*

Here $g(G)$ is the girth of G , i.e. the length of a shortest cycle in G .

Moreover, Albertson *et al.* gave a planar graph G with $\chi_s(G) = 10$ and they observed that for any girth there exists a planar graph G with $\chi_s(G) > 3$.

In this paper, we study the relationship between star coloring and maximum average degree. The maximum average degree of G , denoted by $\text{Mad}(G)$, is defined as:

$$\text{Mad}(G) = \max \left\{ \frac{2 \cdot |E(H)|}{|V(H)|}, H \subset G \right\}.$$

Our main result is the following theorem.

Theorem 2 *Let G be a graph.*

1. *If $\text{Mad}(G) < \frac{26}{11}$, then $\chi_s(G) \leq 4$.*
2. *If $\text{Mad}(G) < \frac{18}{7}$ and $g(G) \geq 6$, then $\chi_s(G) \leq 5$.*
3. *If $\text{Mad}(G) < \frac{8}{3}$ and $g(G) \geq 6$, then $\chi_s(G) \leq 6$.*

It is well-known that if G is a planar graph, then $\text{Mad}(G) < \frac{2 \cdot g(G)}{g(G)-2}$. Hence, we obtain the following corollary.

Corollary 3 *Let G be a planar graph.*

1. *If $g(G) \geq 13$, then $\chi_s(G) \leq 4$.*
2. *If $g(G) \geq 9$, then $\chi_s(G) \leq 5$.*
3. *If $g(G) \geq 8$, then $\chi_s(G) \leq 6$.*

We should note that parts 2 and 3 of Corollary 3 were obtained independently by Timmons [5] and that the proof of Theorem 2 in the present paper uses techniques similar to [5].

Our proofs are based on an extension of an observation by Albertson *et al.* [1] (Lemma 5.1). They noticed that if there exists a partition of the vertices of a graph G such that: $V(G) = F \dot{\cup} I$ and the following two conditions hold:

P1. $G[F]$ is a forest

P2. $G[I]$ is an independent set such that for all $x, y \in I$, $d_G(x, y) > 2$,

then G has a star 4-coloring; we can construct this coloring by star 3-coloring $G[F]$ with color 1, 2, and 3, (see Observation 5) and coloring $G[I]$ with color 4. We extend this idea by using many independent sets satisfying P2 in a certain sense.

In Section 2 we prove Theorem 2.1, in Section 3 we prove Theorem 2.2, and in Section 4 we prove Theorem 2.3. In Section 5, we offer concluding remarks.

Some notation: We use $V(G)$ and $E(G)$ to denote respectively the sets of vertices and edges of a graph G ; we use $\delta(G)$ to denote the minimum degree of G . For a vertex v , we denote by $d(v)$ its degree. A vertex of degree k (resp. at least k , at most k) is called a k -vertex (resp. $\geq k$ -vertex, $\leq k$ -vertex). A k -path is a path of length k (number of edges). A k -thread is a $(k + 1)$ -path whose k internal vertices are of degree 2. A k_{i_1, \dots, i_k} -vertex with $i_1 \leq \dots \leq i_k$ is a k -vertex that is the initial vertex of k threads of lengths i_1, \dots, i_k . Let $S \subset V(G)$; we denote by $G[S]$ the subgraph of G induced by the vertices of S . Let x and y be two vertices of G ; we denote by $d_G(x, y)$ the distance in G between x and y , i.e. the length (number of edges) of a shortest path between x and y in G . In our diagrams, a vertex is colored black if all of its incident edges are drawn; a vertex is colored white if it may have more incident edges than those drawn. We write $S = S_1 \dot{\cup} S_2 \dot{\cup} S_3$ to denote that the S_i s partition the set S .

2 Graphs with $\text{Mad}(G) < \frac{26}{11}$

In this section, we prove that every graph G with $\text{Mad}(G) < \frac{26}{11}$ is star 4-colorable. Lemma 4 refers to an independent set I such that for all $x, y \in I$, $d_G(x, y) > 2$; we call such a set *2-independent*.

Lemma 4 *If $\text{Mad}(G) < \frac{26}{11}$, then there exists a vertex partition $V(G) = I \dot{\cup} F$ such that F induces a forest and I is a 2-independent set.*

Proof.

Let G be a counterexample with the fewest vertices. We may assume that G is connected and has no vertex of degree 1, since such a vertex could be added to F .

We begin by proving four claims about structures that must not appear in G . In each case, let H be the forbidden structure, let $G' = G - H$, and let $V(G') = I' \dot{\cup} F'$ be the desired partition of $V(G')$, which is guaranteed by the minimality of G . We conclude with a discharging argument, which shows that G must contain at least one of these forbidden structures. This contradiction implies that no counterexamples exists, so the lemma is true.

Claim 1: G has no $2_{1,1}$ -vertex.

Suppose x is a $2_{1,1}$ -vertex in G . Consider the partition for the graph obtained by removing x and its neighbors from G . We extend this partition to G . If any of the

second neighbors of x are in I' , then add x and its neighbors to F' . Otherwise, add x to I' and add the neighbors of x to F' .

Claim 2: G has no $3_{1,1,1}$ -vertex adjacent to a $2_{0,1}$ -vertex.

Suppose x is a $3_{1,1,1}$ -vertex adjacent to a $2_{0,1}$ -vertex y . Consider the partition for the graph obtained by removing x, y , and their neighbors from G . If both of the second neighbors of x that are not adjacent to y are in I' , then add all the removed vertices to F' . If both of these second neighbors are in F' , then add x to I' and add all other vertices to F' . Thus, we may assume that one second neighbor of x is in F' , and the other is in I' . If the second neighbor of y not adjacent to x is in I' , then add all vertices to F' . Otherwise, add y to I' and all other vertices to F' .

Claim 3: G has no $4_{1,1,1,1}$ -vertex adjacent to four $2_{0,1}$ -vertices.

Suppose x is such a $4_{1,1,1,1}$ -vertex in G . Consider the partition for the graph obtained by removing x , the neighbors of x , and the second neighbors of x . To extend the partition to G , add x to I' and add the neighbors and second neighbors of x to F' .

We now show that G cannot have certain types of cycles. We want J to be the maximum subgraph of G such that all its vertices either are $2_{0,1}$ -vertices or are $3_{0,1,1}$ -vertices that are adjacent to at least one $2_{0,1}$ -vertex; further, if $d_G(v) = 3$, then we want $d_J(v) \geq 2$. To form J , let A be the set of $2_{0,1}$ -vertices and of $3_{0,1,1}$ -vertices that are adjacent to two $2_{0,1}$ -vertices. Add to A all $3_{0,1,1}$ -vertices that are adjacent to one $2_{0,1}$ -vertex and another $3_{0,1,1}$ -vertex, which is itself adjacent to at least one $2_{0,1}$ -vertex. Let J be the subgraph induced by A .

Claim 4: Every component of J is a tree or a cycle.

Suppose J contains a cycle with vertex set C which contains a vertex r with $d_J(r) = 3$. Choose such a cycle so that $|C|$ is minimal. By minimality C induces a chordless cycle in G .

Let $V(G - C) = F' \cup I'$ be a vertex partition of $G - C$, where we may assume that a 1-vertex in $G - C$ or a 2-vertex adjacent to a 1-vertex is in F' . We extend this partition to all of G in two phases. In phase 1, we will form I'' and F'' by successively adding the vertices of C to I' and F' so that I'' is a 2-independent set in G , and the only possible cycle induced by F'' is C itself. In phase 2, we modify I'' and F'' , if necessary, so that I''' is a 2-independent set and F''' is acyclic.

Before beginning phase 1, we also need two definitions. For convenience, we assign a cyclic orientation to C . If vertices u and v are in $C \cap F''$, then u is a *predecessor* of v if the directed path along C from u to v is entirely in F'' . We say that F'' is *well-behaved*, if for all vertices w, v with $w \in (F'' - C)$, $v \in (F'' \cap C)$, and $vw \in E(G)$, we have either that w is a leaf in F'' or that v has at most two predecessors, each of which is a 2-vertex in G . We now show why it is useful to have F'' well-behaved. Aiming for a contradiction, assume B is a cycle in F'' in which $B \neq C$. Let u and v be the endpoints of a maximal component of $B \cap C$. Without loss of generality, assume u is a predecessor of v . Let w be the neighbor of v not on C . Since w lies on B , w is not a leaf in F'' . Since F'' is well-behaved, the two predecessors of v have degree 2 in G . This contradicts the fact that $d_G(u) = 3$. Observe that at the start of phase 1 we

have $F'' = F'$ and $I'' = I'$ so that F'' is trivially well-behaved. We will ensure that F'' remains well-behaved throughout phase 1, so that at the end of the phase the only possible cycle induced by F'' is C .

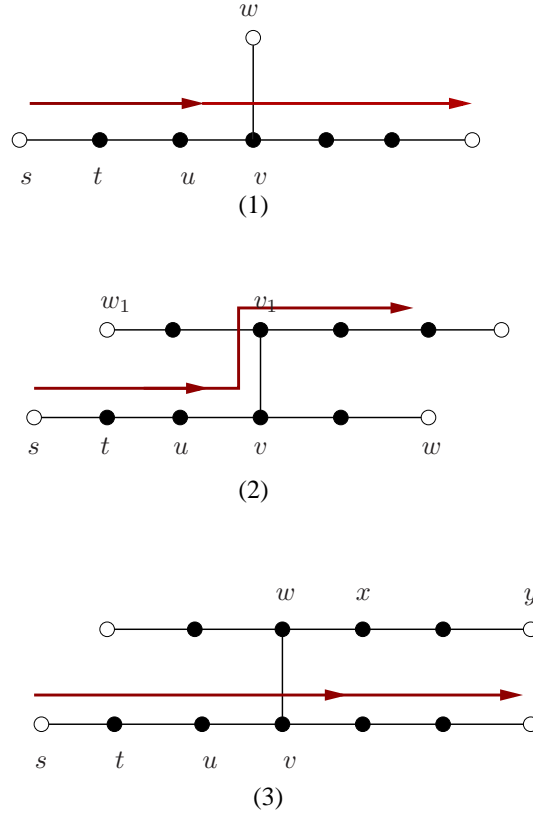

Figure 1: The three key configurations of Claim 4.

To execute phase 1, observe that the immediate neighborhood (in G) of each $3_{0,1,1}$ -vertex v on C must appear as in Figure 1.1 or Figure 1.2, where the arrows indicate C ; recall that the black vertices in the figures have all neighbors shown, but white vertices may have additional neighbors (in G). One by one, we examine the neighborhood of each 3-vertex on C proceeding in the order as we encounter them on C , and assign each vertex either to I'' or F'' . If C contains a vertex v with a 3-neighborhood as in Figure 1.2, then we begin at such a v . Otherwise we choose a 3-vertex v as in Figure 1.1 for which, if possible, $w \in I''$.

Suppose first that the 3-neighborhood of v looks like in Figure 1.1. If s or w is in I'' , then add t, u, v to F'' . If s and w are not in I'' , then add u to I'' and t, v to F'' . This keeps F'' well-behaved: If u is assigned to I'' , then v has no predecessors. If u is not assigned to I'' , then it must be the case that s or w is in I'' . If $s \in I''$, then v has two predecessors, both of which are 2-vertices in G , whereas if $w \in I''$, then F'' is trivially

well-behaved. Suppose then that the neighborhood of v looks like in Figure 1.2. If $w \in F''$, then add v to I'' and t, u, v_1 to F'' . If $w \in I''$, and $w_1 \in F''$, then add v_1 to I'' , and t, u, v to F'' . If $w, w_1 \in I''$, then add t, u, v, v_1 to F'' . To see that F'' is well-behaved, observe that when $w \in F''$, then v is assigned to I'' , so $v \notin F''$ and v_1 has no predecessors. If $w \in I''$, then the neighbor of v not in C is a leaf of F'' . Furthermore, if also $w_1 \in I''$, then the neighbor of v_1 not in C is a leaf in F'' , whereas if $w_1 \in F''$, then $v_1 \notin F''$. This completes phase 1.

If F'' is acyclic, then we have extended the partition to G so we may assume that F'' contains a cycle. Since F'' is well-behaved, this cycle must be C . We correct this problem in phase 2. All of C lies in F'' precisely when for each 3-vertex on C as in Figure 1.1 we have $w \in I''$, and for each 3-vertex as in Figure 1.2 we have $w, w_1 \in I''$. To form I''' and F''' , recall that C contains a vertex r with $d_J(r) = 3$; that is r is adjacent to a $3_{0,1,1}$ -vertex and to two $2_{0,1}$ -vertices. If C runs through $v = r$ as in Figure 1.1, then the immediate neighborhood of v must look like Figure 1.3. In this case we must have $w \in I''$. If also $y \in I''$, then let $I''' = I'' - w + u$, whereas if $y \in F''$, then let $I''' = I'' - w + u + x$. In the remaining case C runs through r as in Figure 1.2. If $r = v$, then w is a 2-vertex with $w \in I''$, which contradicts our assumption that degree 2 vertices adjacent to leaves in $G - C$ are in F' , and thus F'' . If $r = v_1$, then we get a similar contradiction for w_1 . In any case, I''' is 2-independent and $F''' = V(G) - I'''$ is now acyclic, finishing the proof of Claim 4.

Now we prove that every graph G with minimum degree 2 and $\text{Mad}(G) < \frac{26}{11}$ contains one of the configurations forbidden by Claims 1–4. Let G be a counterexample, i.e. a graph with $\delta(G) \geq 2$, with $\text{Mad}(G) < \frac{26}{11}$, and containing none of the configurations forbidden by Claims 1–4.

We use a discharging argument with initial charge $\omega(v) = d(v)$ at each vertex v and with the following four discharging rules (R1) – (R4), where A and J refer to the vertex set and subgraph from Claim 4. We write $\omega^*(v)$ to denote the charge at each vertex v after we apply the discharging rules. If v is a ≥ 3 -vertex, then a 2-vertex w is *nearby* v if v is adjacent to w , or if v and w have a common neighbor of degree 2 (in G).

Note that the discharging rules do not change the sum of the charges. To complete the proof, we show that $\omega^*(v) \geq \frac{26}{11}$ for all $v \in V(G)$; this leads to the following obvious contradiction:

$$\frac{26}{11} \leq \frac{\frac{26}{11}|V(G)|}{|V(G)|} \leq \frac{\sum_{v \in V(G)} \omega^*(v)}{|V(G)|} = \frac{\sum_{v \in V(G)} \omega(v)}{|V(G)|} = \frac{2|E(G)|}{|V(G)|} \leq \text{Mad}(G) < \frac{26}{11}.$$

Hence no counterexample can exist.

The discharging rules are defined as follows.

- (R1) Each ≥ 3 -vertex gives $\frac{2}{11}$ to each nearby 2-vertex.
- (R2) Each $3_{0,1,1}$ -vertex receives $\frac{1}{11}$ from its neighbor of degree at least 3, unless this neighbor is in A in which case no charge is transferred.

(R3) If $d_J(v) = 3$, then v gets $\frac{1}{11}$ from the bank.

(R4) If $v \notin A$ and v is adjacent to k $2_{0,1}$ -vertices, then v gives $\frac{k}{11}$ to the bank.

We now verify that $\omega^*(v) \geq \frac{26}{11}$ for each $v \in V(G)$. Note that each leaf in J is a $2_{0,1}$ -vertex. Hence, by (R4), the bank receives $\frac{1}{11}$ for each leaf of J . By (R3), the bank gives away $\frac{1}{11}$ for each 3-vertex of J . Claim 4 implies that J has average degree at most 2, so J contains at least as many leaves as 3-vertices; hence, the bank has nonnegative charge.

Case $d(v) = 2$ By (R1), v receives $\frac{2}{11}$ from each nearby ≥ 3 -vertex, so $\omega^*(v) = 2 + 2 \cdot \frac{2}{11} = \frac{26}{11}$.

Case $d(v) = 3$ If v is a 3-vertex, then we consider several possibilities:

If v is a $3_{1,1,1}$ -vertex, then by Claim 2, v is not adjacent to a $2_{0,1}$ -vertex. Hence, v does not send any charge to the bank. In this case, $\omega^*(v) = 3 - 3 \cdot \frac{2}{11} = \frac{27}{11}$.

If v is a $3_{0,1,1}$ -vertex adjacent to two $2_{0,1}$ -vertices, then $v \in A$. Let w be the neighbor of v that is not a 2-vertex. If $vw \in E(J)$, then $d_J(v) = 3$. By (R3), v will get $\frac{1}{11}$ from the bank. By (R1), v sends a total of $4 \cdot \frac{2}{11}$ to nearby 2-vertices. Thus $\omega^*(v) = 3 + \frac{1}{11} - 4 \cdot \frac{2}{11} = \frac{26}{11}$. If $vw \notin E(J)$, then $w \notin A$, so that by (R2), v receives $\frac{1}{11}$ from w . Therefore the same calculation applies to v .

If v is a $3_{0,1,1}$ -vertex adjacent to at most one $2_{0,1}$ -vertex, then v gives at most $\frac{1}{11}$ to the bank. Therefore $\omega^*(v) \geq 3 - 3 \cdot \frac{2}{11} - \frac{1}{11} = \frac{26}{11}$.

If v is a 3-vertex adjacent to at most one 2-vertex, then $\omega^*(v) \geq 3 - 2 \cdot \frac{2}{11} - 2 \cdot \frac{1}{11} - \frac{1}{11} = \frac{26}{11}$.

Case $d(v) = 4$ If v is a 4-vertex, then by Claim 3, v is adjacent to at most three $2_{0,1}$ -vertices, so $\omega^*(v) \geq 4 - 7 \cdot \frac{2}{11} - 3 \cdot \frac{1}{11} = \frac{27}{11}$.

Case $d(v) \geq 5$ If v is a ≥ 5 -vertex, then $\omega^*(v) \geq d(v) - \frac{4}{11}d(v) - \frac{1}{11}d(v) = \frac{6}{11}d(v) \geq \frac{30}{11}$.

This implies that $\text{Mad}(G) \geq \frac{26}{11}$, which provides the needed contradiction. \square

Observation 5 *If F is a forest, then $\chi_s(G) \leq 3$.*

In each component T of F , arbitrarily choose a root r ; color each vertex v of T with color $(1 + d_T(r, v)) \pmod{3}$.

Proof of Theorem 2.1

Let G be a graph with $\text{Mad}(G) < \frac{26}{11}$. By Lemma 4, there exists a vertex partition $V(G) = F \dot{\cup} I$. Now we color:

- F with colors 1, 2, and 3 (as in Observation 5), and
- I with color 4.

This produces a star 4-coloring of G . \square

3 Graphs with $\text{Mad}(G) < \frac{18}{7}$ and $g(G) \geq 6$

In this section, we prove that every graph G with $\text{Mad}(G) < \frac{18}{7}$ and $g(G) \geq 6$ is star 5-colorable. The proofs in this section and the next section closely resemble those in Section 2. The main difference is that in both this section and the next, we split the argument into two lemmas, rather than one. In this section, we first prove that each graph of interest must contain one of 14 configurations; we use this lemma to prove a structural decomposition result, which in turns leads to the star coloring result. The outline of Section 4 is similar.

Lemma 6 *A graph G with $\text{Mad}(G) < \frac{18}{7}$ and $g(G) \geq 6$ contains one of the following 14 configurations (see Figures 2 and 3):*

1. A ≤ 1 -vertex.
2. A $2_{1,1}$ -vertex.
3. A $3_{1,1,1}$ -vertex.
4. A $3_{0,0,2}$ -vertex.
5. A $3_{0,1,1}$ -vertex adjacent to a $3_{0,1,1}$ -vertex.
6. A $3_{0,0,1}$ -vertex adjacent to two $3_{0,1,1}$ -vertex.
7. A $4_{1,1,1,2}$ -vertex.
8. A $4_{0,2,2,2}$ -vertex adjacent to a 3-vertex.
9. A $4_{0,1,1,1}$ -vertex adjacent to a $3_{0,1,1}$ -vertex.
10. A $4_{0,1,1,1}$ -vertex adjacent to a $4_{0,2,2,2}$ -vertex.
11. A $4_{0,0,2,2}$ -vertex adjacent to two $4_{0,2,2,2}$ -vertex.
12. A $4_{0,0,2,2}$ -vertex adjacent to a $4_{0,2,2,2}$ -vertex and a $3_{0,1,1}$ -vertex.
13. A $5_{1,2,2,2,2}$ -vertex.
14. A $5_{0,2,2,2,2}$ -vertex adjacent to a $4_{0,2,2,2}$ -vertex.

Proof.

Let G be a counterexample, i.e. a graph with $\text{Mad}(G) < \frac{18}{7}$, with $g(G) \geq 6$, and containing none of the configurations of Lemma 6.

We use a discharging argument with initial charge $\omega(v) = d(v)$ at each vertex v , and with the following four discharging rules (R1) – (R4), which describe how to redistribute the charge. We write $\omega^*(v)$ to denote the charge at each vertex v after we apply the discharging rules. Note that the discharging rules do not change the sum of the charges. To complete the proof, we show that $\omega^*(v) \geq \frac{18}{7}$ for all $v \in V(G)$; this leads to the following obvious contradiction:

$$\frac{18}{7} \leq \frac{\frac{18}{7}|V(G)|}{|V(G)|} \leq \frac{\sum_{v \in V(G)} \omega^*(v)}{|V(G)|} = \frac{\sum_{v \in V(G)} \omega(v)}{|V(G)|} = \frac{2|E(G)|}{|V(G)|} \leq \text{Mad}(G) < \frac{18}{7}.$$

Hence no counterexample can exist.

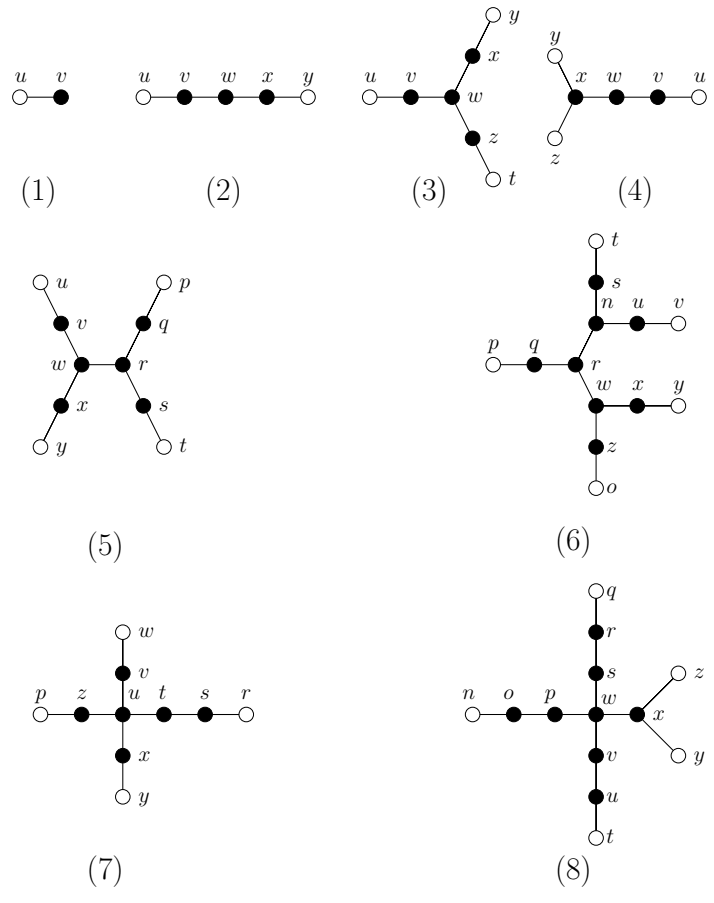
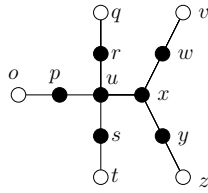
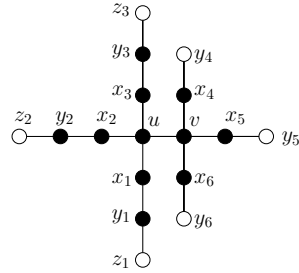

Figure 2: (1 of 2) The first 8 of the 14 unavoidable configurations in Lemma 6.



(9)



(10)

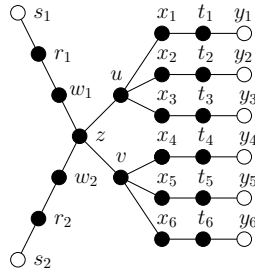

(11)

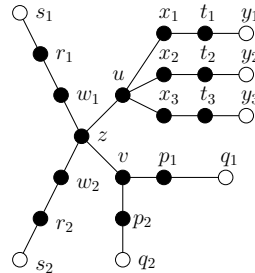

(12)

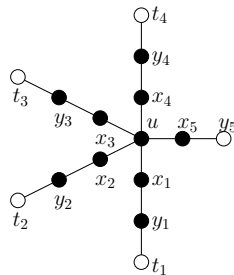

(13)

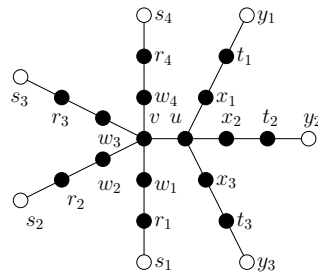

(14)

Figure 3: (2 of 2) The last 6 of the 14 unavoidable configurations in Lemma 6.

The discharging rules are defined as follows.

Each ≥ 3 -vertex gives:

- (R1) $\frac{2}{7}$ to each 2-vertex that is not adjacent to a 2-vertex.
- (R2) $\frac{4}{7}$ to each 2-vertex u that is adjacent to a 2-vertex (u is a $2_{0,1}$ -vertex).
- (R3) $\frac{1}{7}$ to each $3_{0,1,1}$ -vertex.
- (R4) $\frac{2}{7}$ to each $4_{0,2,2,2}$ -vertex.

To complete the proof, it suffices to verify that $\omega^*(v) \geq \frac{18}{7}$ for all $v \in V(G)$.

Case $d(v) = 2$ If v is a $2_{0,1}$ -vertex, then v receives $\frac{4}{7}$ from its neighbor of degree at least 3. Hence, $\omega^*(v) = 2 + \frac{4}{7} = \frac{18}{7}$. Otherwise, v is adjacent to two ≥ 3 -vertices, which each give $\frac{2}{7}$ to v . Hence $\omega^*(v) = 2 + 2 \cdot \frac{2}{7} = \frac{18}{7}$.

Case $d(v) = 3$ By Lemma 6.4, v is not incident to a 2-thread.

If v is a $3_{0,1,1}$ -vertex, then v gives $\frac{2}{7}$ to each adjacent 2-vertex and receives $\frac{1}{7}$ from its third neighbor (since this third neighbor is neither a 2-vertex, nor a $3_{0,1,1}$ -vertex, nor a $4_{0,2,2,2}$ -vertex). Hence, $\omega^*(v) = 3 - 2 \cdot \frac{2}{7} + \frac{1}{7} = \frac{18}{7}$.

If v is a $3_{0,0,1}$ -vertex, then v is adjacent to at most one $3_{0,1,1}$ -vertex and to no $4_{0,2,2,2}$ -vertex. Hence, $\omega^*(v) \geq 3 - \frac{2}{7} - \frac{1}{7} = \frac{18}{7}$.

Finally, assume that v is not adjacent to a 2-vertex. Since v is not adjacent to a $4_{0,2,2,2}$ -vertex, $\omega^*(v) \geq 3 - 3 \cdot \frac{1}{7} = \frac{18}{7}$.

Case $d(v) = 4$ By Lemma 6.8, v is incident to at most three 2-threads.

If v is incident to exactly three 2-threads, then the fourth neighbor of v is neither a 2-vertex, nor a $3_{0,1,1}$ -vertex, nor a $4_{0,2,2,2}$ -vertex; hence, this fourth neighbor gives $\frac{2}{7}$ to v . Thus $\omega^*(v) = 4 - 3 \cdot \frac{4}{7} + \frac{2}{7} = \frac{18}{7}$.

Assume that v is incident to exactly two 2-threads. If the third (or fourth) neighbor of v is a 2-vertex or a $4_{0,2,2,2}$ -vertex, then the final neighbor of v does not receive charge from v (by Lemmas 6.7 and 6.9–6.12). In this case, $\omega^*(v) = 4 - 2 \cdot \frac{4}{7} - \frac{2}{7} = \frac{18}{7}$. It is also possible that one or both of the remaining neighbors of v are $3_{0,1,1}$ -vertices. In this case, $\omega^*(v) \geq 4 - 2 \cdot \frac{4}{7} - 2 \cdot \frac{1}{7} = \frac{18}{7}$.

If v is incident to at most one 2-thread, then $\omega^*(v) \geq 4 - \frac{4}{7} - 3 \cdot \frac{2}{7} = \frac{18}{7}$.

Case $d(v) = 5$ By Lemma 6.13, v is incident to at most four 2-threads.

If v is incident to exactly four 2-threads, then its fifth neighbor is neither a 2-vertex, nor a $4_{0,2,2,2}$ -vertex. Hence, $\omega^*(v) = 5 - 4 \cdot \frac{4}{7} - \frac{1}{7} = \frac{18}{7}$.

If v is incident to at most three 2-threads, then $\omega^*(v) \geq 5 - 3 \cdot \frac{4}{7} - 2 \cdot \frac{2}{7} = \frac{19}{7}$.

Case $d(v) \geq 6$ Trivially, $\omega^*(v) \geq d(v) - d(v) \cdot \frac{4}{7} = \frac{3}{7}d(v) \geq \frac{18}{7}$.

This implies that $\text{Mad}(G) \geq \frac{18}{7}$, which provides the needed contradiction. \square

Lemma 7 *If G is a graph with $\text{Mad}(G) < \frac{18}{7}$ and $g(G) \geq 6$, then there exists a vertex partition $V(G) = F \dot{\cup} I_1 \dot{\cup} I_2$ such that:*

P1. F induces a forest,

P2. I_1 is an independent set such that for all $x, y \in I_1$, $d_{G[F \cup I_1]}(x, y) > 2$, and

P3. I_2 is an independent set such that for all $x, y \in I_2$, $d_G(x, y) > 2$.

This decomposition was first introduced by Timmons in [5].

Proof.

Let G be a counterexample with the fewest vertices. By Lemma 6, G contains one of the 14 configurations shown in Figures 2 and 3. In each configuration, let N denote the set of black vertices. In each case, we delete a subgraph H and partition $V(G-H)$ into sets F' , I'_1 , and I'_2 that satisfy P_1 , P_2 , and P_3 . We now show how to add the deleted vertices to F' , I'_1 , and I'_2 so that the resulting sets still satisfy P_1 , P_2 , and P_3 .

We consider each of the 14 configurations in Figures 2 and 3.

- (1) Let $G' = G - v$. By the minimality of G , the vertex set of G' is the disjoint union of sets F' , I'_1 , and I'_2 that satisfy P1, P2, and P3. Now add v to F' .
 - (2) Let $G' = G \setminus N$. If $u, y \in F'$, then add v and x to F' and add w to I'_1 . Otherwise, add v, w, x to F' .
 - (3) Let $G' = G \setminus N$. If $u, y, t \in F'$, then add v, x, z to F' and add w to I'_1 . If exactly two of the vertices u, y, t are in F' , then w.l.o.g. $u, y \in F'$ and $t \in I_1$ (resp. I_2); add v, x, z to F' and add w to I'_2 (resp. I'_1). If at most one of the vertices u, y, t is in F' , then add v, w, x, z to F' .
 - (4) Let $G' = G \setminus \{v, w\}$. Consider the case $u, x \in F'$. If $y, z \in I'_1 \cup I'_2$ then add v and w to F' . Otherwise: if $y, z \in I'_2 \cup F'$, then add v to F' and w to I'_1 ; similarly, if $y, z \in I'_1 \cup F'$, then add v to F' and add w to I'_2 . Finally, if $u \notin F'$ or $x \notin F'$, then add v and w to F' .
 - (5) Let $G' = G \setminus N$. If $u, p, y, t \in F'$, then add v, q, x, s to F' , add w to I'_1 , and add r to I'_2 . If exactly three of u, p, y, t are in F' , then W.l.o.g., $u, p, y \in F'$ and $t \in I'_1$; add w to I'_1 and v, p, r, s, x to F' . The remaining cases are easier and are left to the reader.
- (6)-(9) These easy cases are left to the reader.
- (10) Let $G' = G \setminus N$. We consider two cases: (i) If at least two of y_4, y_5, y_6 are in independent sets, then add u to an independent set and add the other vertices to the forest; (ii) If at most one of y_4, y_5, y_6 is in an independent set, then add v to the other independent set and add all the other vertices to the forest.
 - (11) Let $G' = G \setminus N$. Add u and v to I_1 , add z to I_2 , and add all the other vertices to the forest.
 - (12) Let $G' = G \setminus N$. We just consider the case where q_1 and q_2 are in F' ; the remaining cases are easier. Add u and v to I_1 , add z to I_2 , and add the other vertices to the forest.

- (13) Let $G' = G \setminus N$. Add u to an independent set that doesn't contain y_5 and add all the other vertices to the forest.
- (14) Let $G' = G \setminus N$. Add u to I'_1 , add v to I'_2 , and add all other other vertices to the forest.

□

Proof of Theorem 2.2

Let G be a graph with $\text{Mad}(G) < \frac{18}{7}$ and $g(G) \geq 6$. By Lemma 7, there exists a vertex partition $V(G) = F \dot{\cup} I_1 \dot{\cup} I_2$. Now we color:

- $G[F]$ with the colors 1, 2, and 3 (as in Observation 5),
- $G[I_1]$ with the color 4, and
- $G[I_2]$ with the color 5.

This produces a star 5-coloring of G .

□

Observation 8 *The condition $g(G) \geq 6$ can be dropped. Since there are no 3-threads, we just use this assumption to ensure that white and black vertices are distinct in the configurations in Figures 2 and 3.*

4 Graphs with $\text{Mad}(G) < \frac{8}{3}$ and $g(G) \geq 6$

In this section, we prove that every graph G with $\text{Mad}(G) < \frac{8}{3}$ and $g(G) \geq 6$ is star 6-colorable.

Lemma 9 *A graph G with $\text{Mad}(G) < \frac{8}{3}$ and $g(G) \geq 6$ contains one of the following 8 configurations:*

1. A ≤ 1 -vertex.
2. A $2_{0,1}$ -vertex adjacent to a ≤ 4 -vertex.
3. A $3_{0,1,1}$ -vertex adjacent to a ≤ 3 -vertex.
4. A $k_{1,1,2,\dots,2}$ -vertex.
5. A $k_{0,2,\dots,2}$ -vertex adjacent to a 3-vertex.
6. A $k_{0,1,2,\dots,2}$ -vertex adjacent to $k'_{0,1,1,2,\dots,2}$ -vertex.
7. A $k_{0,0,2,\dots,2}$ -vertex adjacent to two $3_{0,1,1}$ -vertices.
8. A $k_{0,0,2,\dots,2}$ -vertex adjacent to a $k'_{0,1,1,2,\dots,2}$ -vertex and to a $k''_{0,1,2,2,\dots,2}$ -vertex.

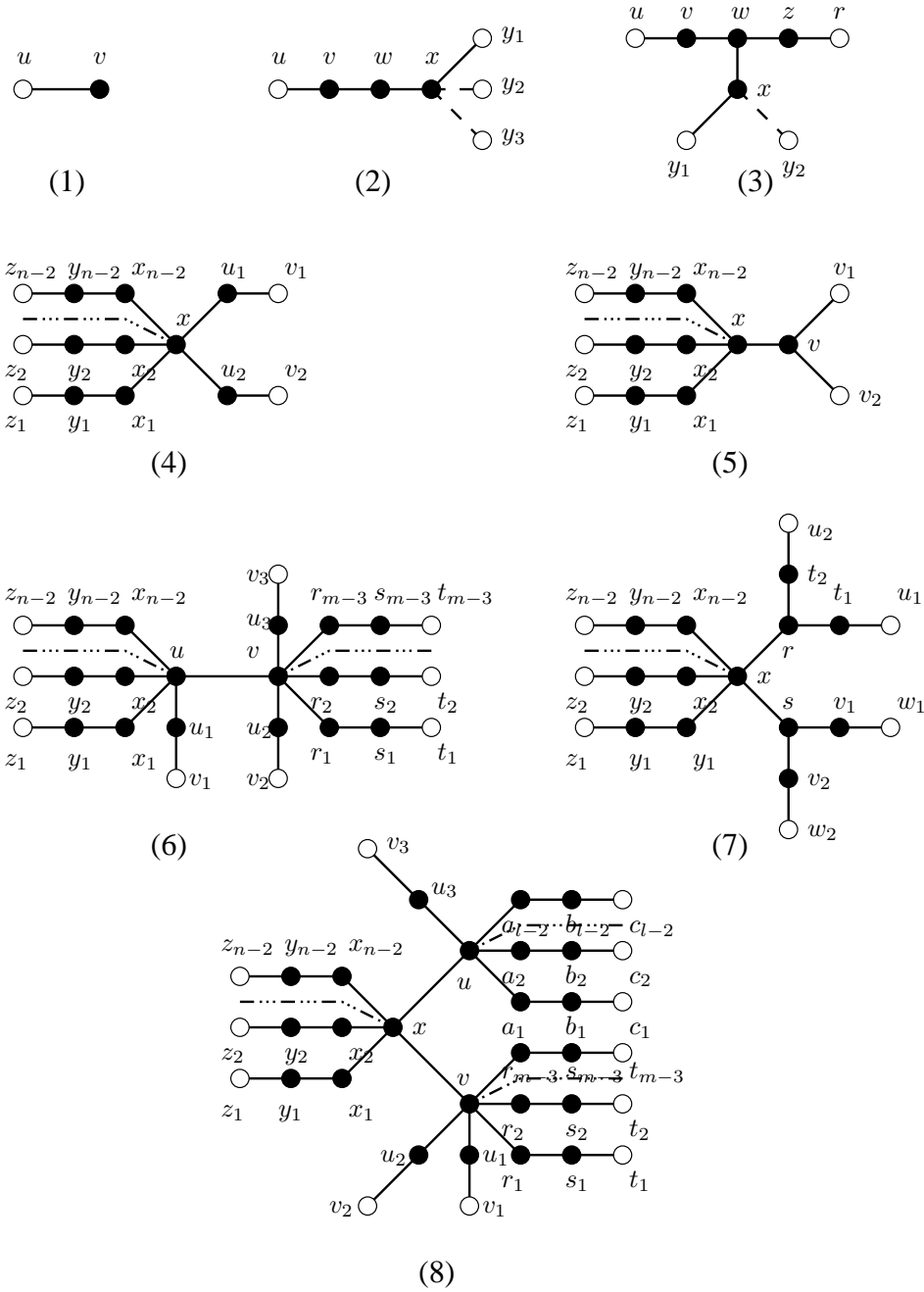

Figure 4: The 8 unavoidable configurations in Lemma 9.

Proof.

Our proof is similar to the proofs of Lemmas 4 and 6. Let G be a counterexample.

We use a discharging argument with initial charge $\omega(v) = d(v)$ at each vertex v , and with the following three discharging rules (R1) – (R3), which describe how to redistribute the charge. We write $\omega^*(v)$ to denote the charge at each vertex v after we apply the discharging rules. Note that the discharging rules do not change the sum of the charges. To complete the proof, we show that $\omega^*(v) \geq \frac{8}{3}$ for each $v \in V(G)$; this leads to the following obvious contradiction:

$$\frac{8}{3} \leq \frac{\frac{8}{3}|V(G)|}{|V(G)|} \leq \frac{\sum_{v \in V(G)} \omega^*(v)}{|V(G)|} = \frac{\sum_{v \in V(G)} \omega(v)}{|V(G)|} = \frac{2|E(G)|}{|V(G)|} \leq \text{Mad}(G) < \frac{8}{3}.$$

Hence no counterexample can exist.

The discharging rules are defined as follows.

- (R1) Each ≥ 5 -vertex gives $\frac{2}{3}$ to each adjacent 2-vertex u which is adjacent to a 2-vertex (u is a $2_{0,1}$ -vertex).
- (R2) Each ≥ 3 -vertex gives $\frac{1}{3}$ to each adjacent 2-vertex which is not adjacent to a 2-vertex.
- (R3) Each ≥ 4 -vertex gives $\frac{1}{3}$ to each adjacent $3_{0,1,1}$ -vertex and $\frac{1}{3}$ to each adjacent $5_{0,2,2,2,2}$ -vertex.

We call $3_{0,1,1}$ -vertices and $5_{0,2,2,2,2}$ -vertices *light vertices*. If a vertex is the initial or final vertex of a thread, we call it an *end* of the thread. By Lemma 9.1., $\delta(G) \geq 2$.

Case $d(v) = 2$ If v is not adjacent to any 2-vertices, then it receives $\frac{1}{3}$ from each neighbor by (R2); so, $\omega^*(v) = 2 + 2 \cdot \frac{1}{3} = \frac{8}{3}$. If v is a $2_{0,1}$ -vertex, then it is adjacent to a ≥ 5 -vertex. By (R3), u gives $\frac{2}{3}$ to v , so $\omega^*(v) = 2 + \frac{2}{3} = \frac{8}{3}$.

Case $d(v) = 3$ By Lemma 9.2 and the girth condition, v is not the end of a 2-thread. Moreover, by Lemma 9.3, v is the end of at most two 1-threads.

If v is the end of exactly two 1-threads, then it is adjacent to a ≥ 4 -vertex, by Lemma 9.3. So, $\omega^*(v) = 3 - 2 \cdot \frac{1}{3} + \frac{1}{3} = \frac{8}{3}$ by (R2) and (R3).

If v is the end of at most one 1-thread, then $\omega^*(v) \geq 3 - \frac{1}{3} = \frac{8}{3}$.

Case $d(v) = 4$ By (R2) and (R3), $\omega^*(v) \geq 4 - 4 \cdot \frac{1}{3} = \frac{8}{3}$.

Case $d(v) = 5$ By Lemma 9.4, v is the end of at most four 2-threads.

If v is the end of exactly four 2-threads (v is light), then it is neither adjacent to a ≤ 3 -vertex, by Lemmas 9.4 and 9.5, nor to a $5_{0,2,2,2,2}$ -vertex, by Lemma 9.6. Hence, v receives $\frac{1}{3}$ by (R3). So, $\omega^*(v) = 5 - 4 \cdot \frac{2}{3} + \frac{1}{3} = \frac{8}{3}$.

If v is the end of exactly three 2-threads, then v is adjacent to at most one light vertex, by Lemmas 9.7 and 9.8. So, $\omega^*(v) \geq 5 - 3 \cdot \frac{2}{3} - \frac{1}{3} \geq \frac{8}{3}$.

Finally, if v is the end of at most two 2-threads, then $\omega^*(v) \geq 5 - 2 \cdot \frac{2}{3} - 3 \cdot \frac{1}{3} \geq \frac{8}{3}$.

Case $d(v) \geq 6$ By Lemma 9.4, v is the end of at most $d(v) - 1$ 2-threads.

If v is the end of exactly $d(v) - 1$ 2-threads, then it is neither adjacent to a ≤ 3 -vertex, by Lemmas 9.4 and 9.5, nor to a $5_{0,2,2,2,2}$ -vertex, by Lemma 9.6; hence, $\omega^*(v) = d(v) - (d(v) - 1) \cdot \frac{2}{3} \geq \frac{8}{3}$.

If v is the end of exactly $d(v) - 2$ 2-threads, then v is adjacent to at most one light vertex, by Lemmas 9.7 and 9.8. So, $\omega^*(v) \geq d(v) - (d(v) - 2) \cdot \frac{2}{3} - \frac{1}{3} \geq 3$.

Finally, if v is the end of at most $d(v) - 3$ 2-threads, then $\omega^*(v) \geq d(v) - (d(v) - 3) \cdot \frac{2}{3} - 3 \cdot \frac{1}{3} \geq 3$.

This implies that $\text{Mad}(G) \geq \frac{8}{3}$, which provides the needed contradiction. \square

Lemma 10 *Let G be a graph with $\text{Mad}(G) < \frac{8}{3}$ and $g(G) \geq 6$. Then there exists a vertex partition $V(G) = F \dot{\cup} I_1 \dot{\cup} I_2 \dot{\cup} I_3$ such that:*

P1. F induces a forest.

P2. I_i is an independent set such that for all $x, y \in I_i$, $d_G(x, y) > 2$ for $i = 1, 2, 3$.

Proof.

Let G be a counterexample with the fewest vertices. By Lemma 9, G contains one of the 8 configurations in Figure 4. In each configuration, let N denote the set of black vertices. In each case, we delete a subgraph H and partition $V(G - H)$ into sets F' , I'_1 , I'_2 , and I'_3 that satisfy P_1 and P_2 . We now show how to add the deleted vertices to F' , I'_1 , I'_2 , and I'_3 so that the resulting sets still satisfy P_1 and P_2 .

We consider each of the 8 configurations in Figure 4:

- (1) Let $G' = G - v$. By the minimality of G , there exists a vertex partition $V(G') = F' \dot{\cup} I'_1 \dot{\cup} I'_2 \dot{\cup} I'_3$ satisfying P_1 and P_2 . Add v to F' .
- (2) Let $G' = G \setminus \{v, w\}$ and $V(G') = F' \dot{\cup} I'_1 \dot{\cup} I'_2 \dot{\cup} I'_3$. If at least one of the vertices u and x belongs to an independent set, then add v and w to F' . So assume that $x, u \in F'$. If all three y_i s are in distinct independent sets, then add v and w to F' . Otherwise, add v to the forest and add w to an independent set that does not contain any y_i .
- (3) Let $G' = G \setminus \{v, w, z\}$. If three or more of the vertices u, r, y_1, y_2 belong to independent sets, then add u, w, z to the forest. So suppose that at most two of these vertices belong to independent sets. Add w to an independent set that does not contain any of u, r, y_1, y_2 ; add all the other vertices to the forest. It may happen that w and x are in the same independent set; in this case, we can either add u, w, z to the forest or we can move x to the forest.
- (4) Let $G' = G \setminus N$. Add x to an independent set that contains neither v_1 nor v_2 and add all the other vertices to the forest.
- (5) Let $G' = G \setminus \{\text{black vertices except } v\}$. Add x to an independent set that contains neither v_1 nor v_2 and add all the other vertices to the forest (move v to the forest if necessary).

- (6) Let $G' = G \setminus N$. Add v to an independent set that contains neither v_2 nor v_3 , add u to an independent set that contains neither v nor v_1 , and add all the other vertices to the forest.
- (7) Let $G' = G \setminus N$. Add r to an independent set that contains neither u_1 nor u_2 , and add s to an independent set that contains neither w_1 , nor u_2 , nor r ; if there is no choice for s , then add s to the forest. Add x to an independent set that contains neither r nor s , and add all the other vertices to the forest.
- (8) Let $G' = G \setminus N$. Add v to an independent set that contains neither v_1 nor v_2 , add u to an independent set that contains neither v nor v_3 , and add x to an independent set that contains neither u nor v . Finally, add all the other vertices to the forest.

□

Proof of Theorem 2.3

Let G be a graph with $\text{Mad}(G) < \frac{8}{3}$ and $g(G) \geq 6$. By Lemma 10, there exists a vertex partition $V(G) = F \dot{\cup} I_1 \dot{\cup} I_2 \dot{\cup} I_3$. Now we color:

- F with the colors 1, 2, and 3 (as in Observation 5),
- I_1 with the color 4,
- I_2 with the color 5, and
- I_3 with the color 6.

This produces a star 6-coloring of G .

□

Observation 11 *The condition $g(G) \geq 6$ can be dropped. Since there are no 3-threads, we just use this assumption to ensure that white and black vertices are distinct in the configurations in Figure 4.*

5 Conclusion

In this paper, we proved that if G is a graph with $\text{Mad}(G) < \frac{26}{11}$ (resp. $\text{Mad}(G) < \frac{18}{7}$ and $g(G) \geq 6$, $\text{Mad}(G) < \frac{8}{3}$ and $g(G) \geq 6$), then $\chi_s(G) \leq 4$ (resp. 5, 6). Are these results optimal? Let us define a function f as follows.

Definition 12 *Let $f : \mathbb{N} \rightarrow \mathbb{R}$ be defined by*

$$f(n) = \inf\{\text{Mad}(H) \mid \chi_s(H) > n\}$$

Observe that:

$$f(1) = 1.$$

Actually, if G contains an edge, then $\chi_s(G) > 1$; otherwise, G is an independent set, so $\chi_s(G) = 1$ and $\text{Mad}(G) = 0$. Note also that:

$$f(2) = \frac{3}{2}.$$

If G contains a path of length 3, then $\chi_s(G) > 2$ and $\text{Mad}(G) \geq \frac{3}{2}$. Otherwise, G is a star forest, so $\chi_s(G) \leq 2$ and $\text{Mad}(G) < 2$. Finally, note that:

$$f(3) = 2.$$

If $\text{Mad}(G) < 2$, then G is a forest and $\chi_s(G) = 3$. In contrast, if G is a 5-cycle, then $\text{Mad}(G) = 2$ and $\chi_s(G) = 4$.

Problem 13 What is the value of $f(n)$ for $n = 4, 5, 6$?

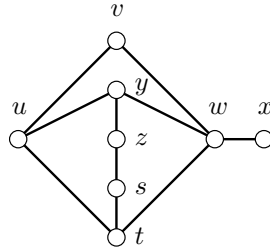

Figure 5: A graph G with $\text{Mad}(G) = \frac{18}{7}$ and $\chi_s(G) > 4$.

From Theorem 2.1, we know that:

$$\frac{26}{11} \leq f(4).$$

The graph G , in Figure 5, has $\text{Mad}(G) = \frac{18}{7}$ and $\chi_s(G) > 4$, so G gives an upper bound on $f(4)$. Hence:

$$\frac{26}{11} = \frac{182}{77} \leq f(4) \leq \frac{198}{77} = \frac{18}{7}$$

Finally, observe that there exists a star 4-colorable graph G with $\text{Mad}(G) = \frac{5}{2}$ that does not admit a partition $V = F \dot{\cup} I$ such that for all $x, y \in I$, $d_G(x, y) > 2$. See Figure 6.

6 Acknowledgements

Thanks to Craig Timmons and André Kündgen for helpful discussions.

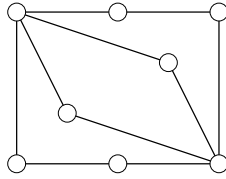

Figure 6: A star 4-colorable graph G with $\text{Mad}(G) = \frac{5}{2}$ that has no partition $F \dot{\cup} I$ such that for all $x, y \in I$, $d_G(x, y) > 2$.

References

- [1] M.O. Albertson, G.G. Chappell, H.A. Kierstead, A. Kündgen, and R. Ramamurthi. Coloring with no 2-colored P_4 's. *The Electronic Journal of Combinatorics*, 11(1):R26, 2004.
- [2] G. Fertin, A. Raspaud, and B. Reed. On star coloring of graphs. *LNCS*, 2204:140–153, 2001.
- [3] B. Grünbaum. Acyclic colorings of planar graphs. *Israel J. Math.*, 14:390–408, 1973.
- [4] J. Nešetřil and P. Ossana de Mendez. Colorings and homomorphisms of minor closed classes. *Discrete and Computational Geometry: The Goodman-Pollack Festschrift*, 651–664, 2003.
- [5] C. Timmons. Star coloring planar graphs. *Master thesis*, California State University San Marcos, May 2007.